

CODE NUMBER

3315185BT

DESCRIPTION

Bluetooth, 4" Trim Plate, Battery Power Supply, Below Deck
 Thermostatic Mixing Valve, Polished Chrome Finish, 2.2 gpm, Laminar
 Spray, Infrared Sensor, Optima® Battery or Turbine-Powered Deck-
 Mounted Gooseneck Body.

DETAILS

- Flow Rate: 2.2 gpm (8.3 Lpm) (2.2GPM)
- Spray Type: Laminar (LAM)
- Sensor Type: Infrared
- Mounting Type: Single Hole
- Mounting Size: Single Hole 1-1/4" to 1-1/2"
- Trim Plate: 4" (102mm) (4)
- Power Supply: Battery (BAT)
- Temperature Mixer: Below Deck Thermostatic Mixing Valve (BDT)
- Finish: Polished Chrome (CP)
- Factory Default Timeout: 30 seconds
- Factory Default Gallons per Cycle: 1.1

FEATURES

ADA Compliant, Water Usage and Battery Strength Reporting,
 Wireless Settings Adjustment, Commercial Grade Faucet, Integrated
 Water Shut-off, Hygienic Line Flush, On-demand or Metered
 Activation, Self-adapting Sensor, Cast Brass Spout, Quick Connect
 Fittings

ELECTRICAL SPECIFICATIONS

- Battery Life: 3 years 8,000 cycles/month
 - Optional power harvesting significantly extends service life
- Sensor Range: 8" - 10" (203 - 254mm)
- Timeout Adjustment Settings: 30s

POWER SUPPLY OPTIONS

- 6VDC Plug Adapter (sold separately), 0362006*
- 6VDC Ganged Adapter Kit (up to 6 units)(sold separately), 0362035*
- 24VAC Box Transformer (up to 3 units)(sold separately), 0345370PK*
- Optional Turbine Energy Harvesting

* when converting units to hardwired with battery back-up

VIDEOS

- ▶ Sloan Connect App®
- ▶ Sloan Optima Below Deck Faucet

DOWNLOADS

- [Optima Smart Faucet Below Deck Installation Instructions](#)
- [Faucet Spray Heads Repair and Maintenance Guide](#)
- [ETF-700/700-S and EBF-750/750-S Below Deck Repair and Maintenance Guide](#)

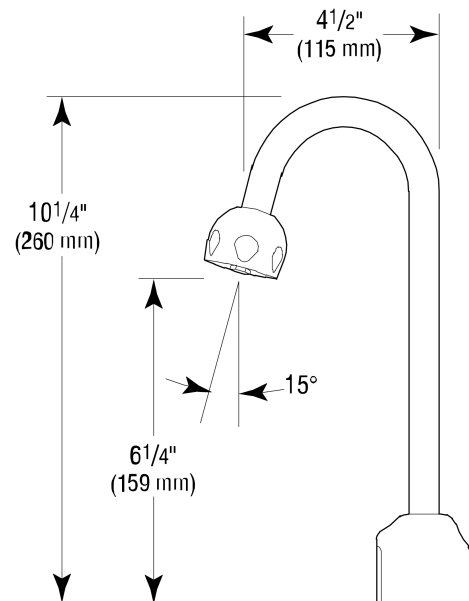

COMPLIANCES & CERTIFICATIONS



(ADA Compliant, ASME A112.18.1 Compliant, ASSE 1070, cUPC Certified, UPC Certified, UPC Low Lead Compliant, cUPC Low Lead Compliant, EPD, HPD, IAPMO, WaterSense Listed, NSF-61, Proposition 65, TAS, WELL Building Standard)

RECOMMENDED SPECIFICATION

Faucet shall include cast brass body, quick-connect fittings, twist-off/shut-off solenoid assembly, removable battery cartridge, flexible power supply and allow adjustment of settings wirelessly via Apple or Android smartphones.

Sloan 10500 Seymour Ave, Franklin Park, IL 60131
 Phone: 800.982.5839 • Fax: 800.447.8329 • sloan.com

- [Trim Plate Guide](#)
- [Additional Downloads](#)

NOTES

All information contained within this document subject to change without notice.

Looking for other variations of the EBF-750 product? [View the general spec sheet with all options.](#)

[Find a matching soap dispenser](#) for this faucet.

[Find a compatible sink](#) for this faucet.

WARRANTY

[View Warranty Information](#)

ROUGH-IN

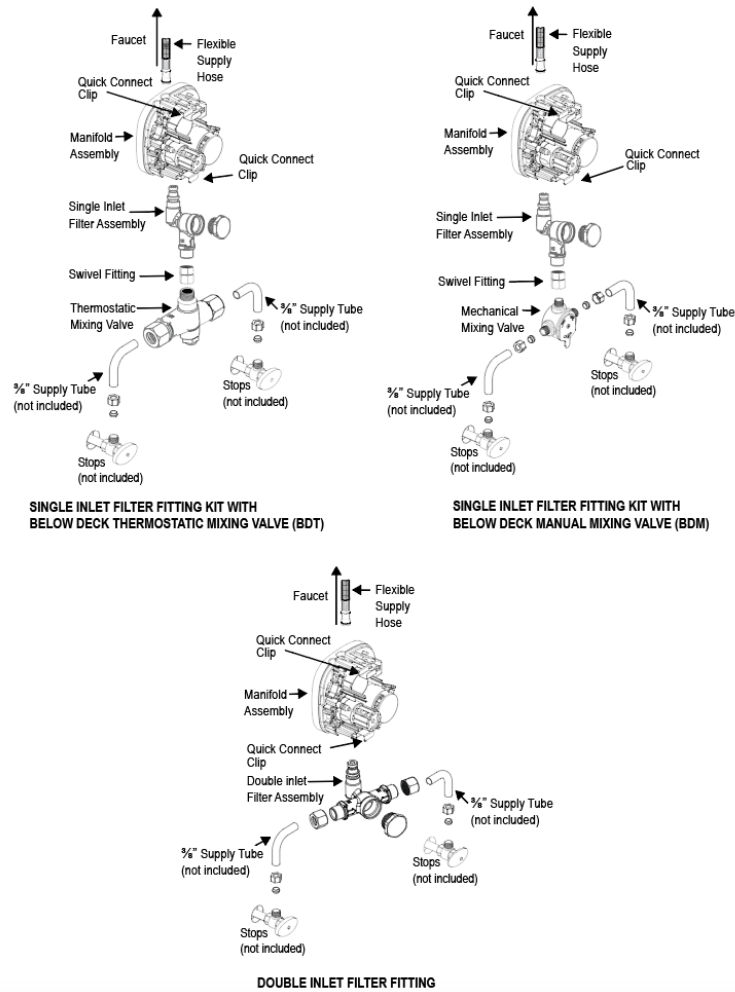

Sloan 10500 Seymour Ave, Franklin Park, IL 60131

Phone: 800.982.5839 • Fax: 800.447.8329 • sloan.com